

Article number: 203360M16150B1VK

Description: E+G levelling foot
GN 33-60-M16-150-B1-VK, Stainless steel

Note: VK With nut, External hexagon at the top, Wrench flat at the bottom

Measures

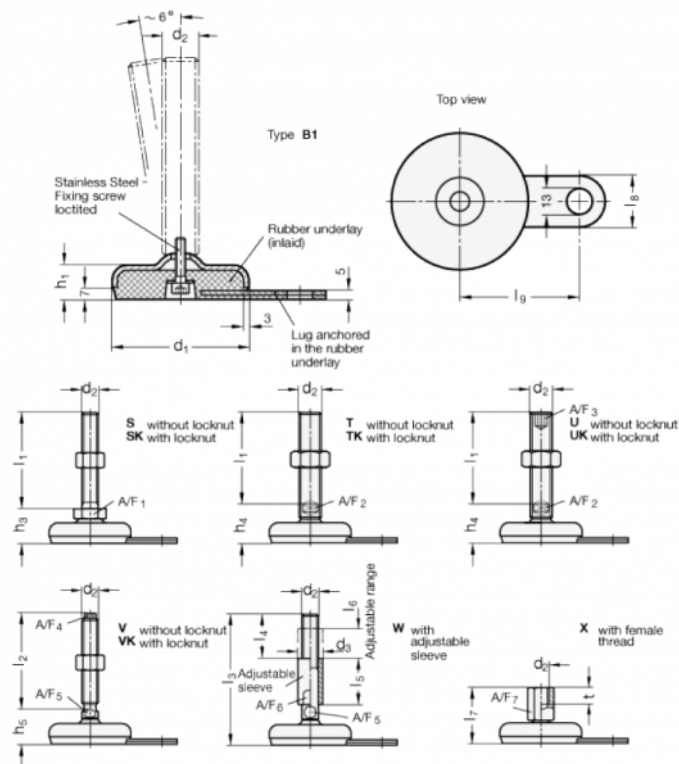

A/F4 = 10

I9 = 50

A/F5 = 12

d1 = 60

d2 = M16

h1 = 19

h4 = 30

l2 = 150

l8 = 25